

Article number: 0106067

Description: Retaining ring JV 50

Measures

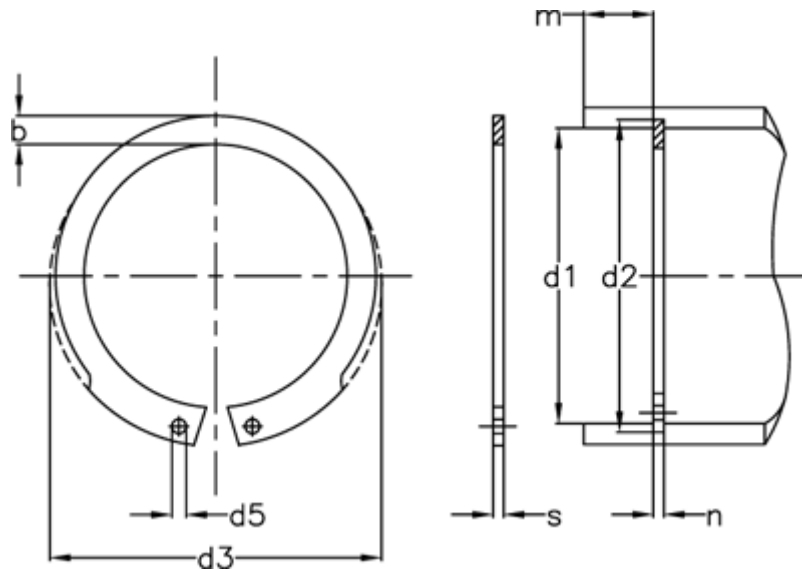

AN mm ²	= 120	FRg kN	= 13.4	tol	= 0.2
b	= 5.2	FR kN	= 69.0	tol	= -0.07
d1	= 50	g	= 2.0	tol	= +1,10-0,46
d2	= 53.0	K kN-mm	= 124.0	tol	= +0,30
d3	= 54.2	m min	= 2.15	Tong	= ZGJ-3
d5 min	= 2.5	Nominal drive	= 4.5	Weight kg/1000	= 8.50
Description	= JV 50	s	= 2.00		
FN kN	= 20.00	t	= 1.50		